

Schema explodată Masina de taiat asfalt / beton Bisonte MTA 501

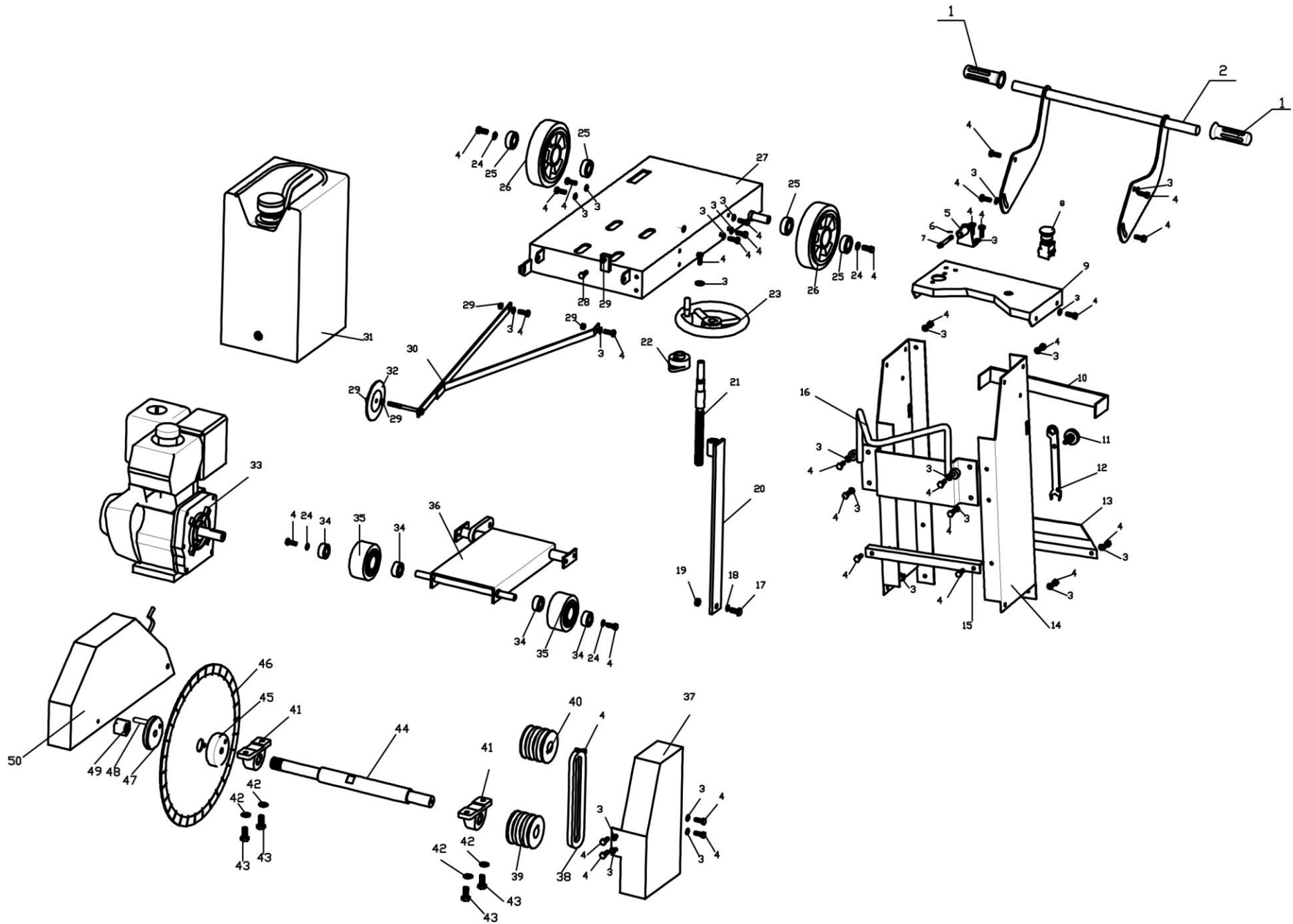

Schema explodata Masina de taiat asfalt / beton Bisonte MTA 501





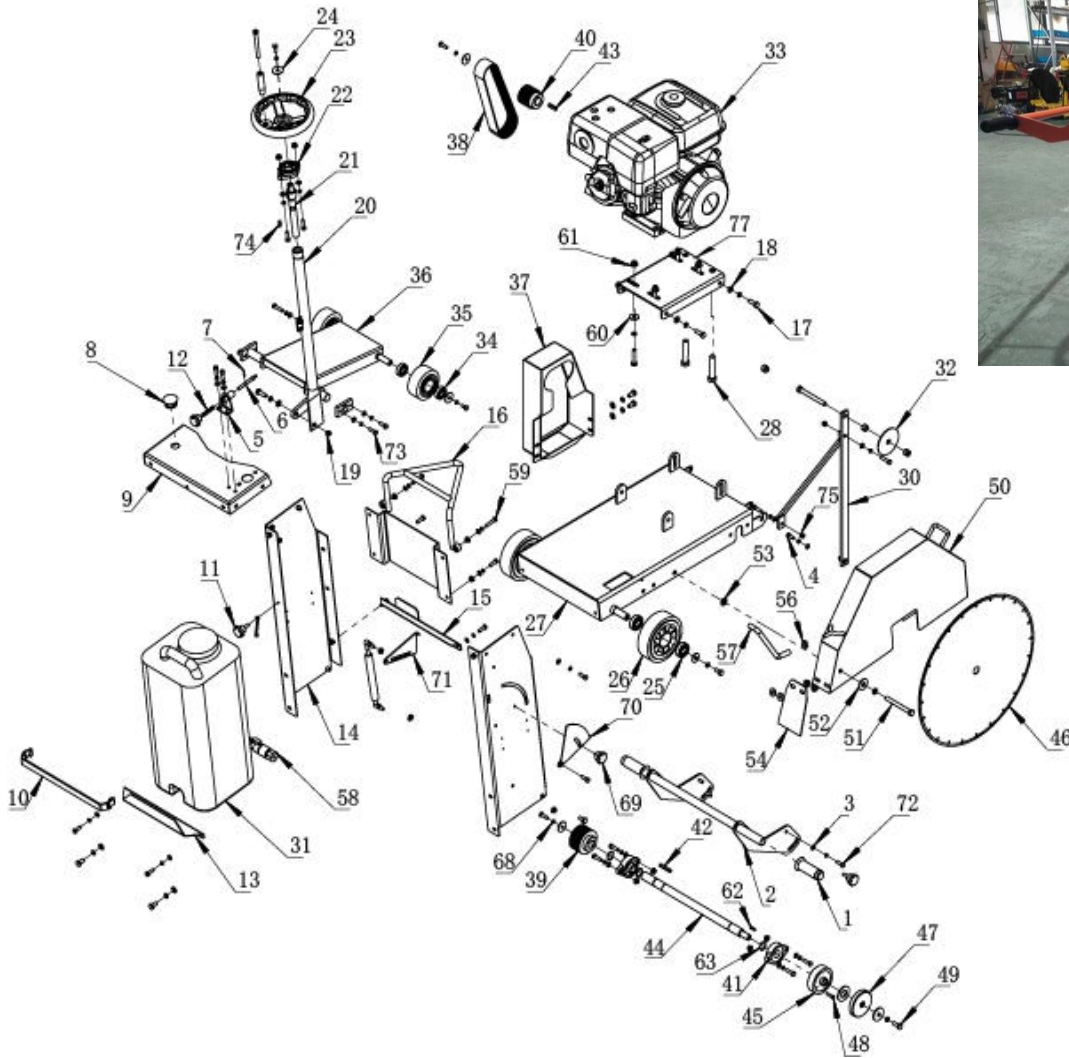

No.	PART NO.	DESCRIPTION	Quantity
1	CNQ20B001	Handle grip	2
2	CNQ20B002	Handle (set)	1
3	CNQ20B003	Flat washer M8	32
4	CNQ20B004	Screw M8*20	36
5	CNQ20B005	Lock system	1
6	CNQ20B006	Lock pin	1
7	CNQ20B007	Lock pin	1
8	CNQ20B008	Switch,emergency stop	1
9	CNQ20B009	Cover of water tank	1
10	CNQ20B010	Bandage	1
11	CNQ20B011	Knob	1
12	CNQ20B012	Wrench	1
13	CNQ20B013	Rear support plate for water tank	1
14	CNQ20B014	Side plate for water tank	1
15	CNQ20B015	Front support plate for water tank	1
16	CNQ20B016	Lifting hook	1
17	CNQ20B017	Screw M10*30	1
18	CNQ20B018	Flat washerφ10	1
19	CNQ20B019	Screw M10	1
20	CNQ20B020	Jackpost assy.	1
21	CNQ20B021	Jackscrew	1
22	CNQ20B022	Bearing LF204	1
23	CNQ20B023	Wheel	1
24	CNQ20B024	Bigger flat washer φ8	2
25	CNQ20B025	Bearing for real shaft	4
26	CNQ20B026	Rear wheel	2
27	CNQ20B027	Base plate	1

No.	PART NO.	DESCRIPTION	Quantity
28	CNQ20B028	Screw M8*90	1
29	CNQ20B029	Nut M8	6
30	CNQ20B030	Pointer arm	1
31	CNQ20B031	Water tank	1
32	CNQ20B032	Pointer wheel	1
33	CNQ20B033	Engine	1
34	CNQ20B034	Bearing for front wheel	4
35	CNQ20B035	Front wheel	2
36	CNQ20B036	Wheel rack module	1
37	CNQ20B037	Belt cover	1
38	CNQ20B038	Belt	3
39	CNQ20B039	Pulley, driven	1
40	CNQ20B040	Pulley,engine	1
41	CNQ20B041	Bearing seat UCP206	2
42	CNQ20B042	Bigger flat washer φ12	4
43	CNQ20B043	Screw M12*40	4
44	CNQ20B044	Main shaft	1
45	CNQ20B045	Blade flange (inner)	1
46	CNQ20B046	Blade	1
47	CNQ20B047	Blade flange(outer)	1
48	CNQ20B048	Pin,flange	1
49	CNQ20B049	Screw for main shaft	1
50	CNQ20B050	Blade cover	1

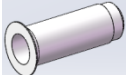
MTA 501 PARTS LIST

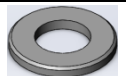
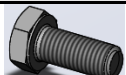
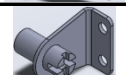
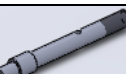
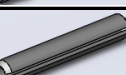

stand:25.09.2018



PART NO.	Image	DESCRIPTION	Quantity	
1		Handle grip	2	
2		Handle (set)	1	
3		Flat washer M8	32	
4		Screw M8*20	36	
5		Lock system	1	
6		Lock pin	1	
7		Lock pin	1	
8		Switch, emergency stop	1	
9		Cover of water tank	1	
10		Bandage	1	

11		Clamping knob M8	1	
12		Spring	1	
13		Rear support plate for water tank	1	
14-1		Left side plate for water tank	1	
14-2		Right side plate for water tank	1	
15		Front support plate for water tank	1	
16		Lifting hook	1	
17		Screw M10*30	1	
18		Flat washer φ10	1	
19		Locknut M10	3	
20		Jackpost assy.	1	
21		Jackscrew	1	
22		Bearing LF204	1	
23		Wheel	1	
24		Bigger flat washer φ8	7	
25		Bearing for real shaft	4	
26		Rear wheel	2	
27		Base plate	1	
28		Screw M8*90	1	
29		Nut M8	6	
30		Pointer arm	1	
31		Water tank	1	
32		Pointer wheel	1	
33		Engine	1	
34		Bearing for front wheel	4	
35		Front wheel	2	

36		Wheel rack module	1	
37		Belt cover	1	
38		Belt	2	
39		Pulley, driven	1	
40		Pulley, engine	1	
41		Bearing seat LF205	2	
42		Flat key for main shaft 8x7x20	1	
43		Flat key for driving pulley 7x7x25	1	
44		Main shaft	1	
45		Blade flange (inner)	1	
46		Blade	1	
47		Blade flange(outer)	1	
48		Screw	1	
49		Screw M12X30	1	
50		Blade cover	1	
51		Screw M12X100	1	
52		Washer M12	2	
53		Nylon washer M12	1	
54		Rubber mat	1	
55		Screw M6x16	2	
56		Clamp	2	
57		Water pipe	1	
58		Cock 1/2	1	
59		Screw M10X45	4	
60		Bigger flat washer φ10	4	
61		Washer M10	4	

62		Key 5x5x20	1	
63		Circlip Φ25	3	
64		Spring washer M8	7	
65		Plate for wheel rack module	2	
66		Socket head bolt M8x30	1	
67		Bolt M8		
68		Front guard for water tank	1	
69		Clamping knob M8x10	1	
70		Outer indicator	1	
71		Inner indicator	1	
72		Hex bolt M8x30	1	
73		Hex bolt M8x25	6	
74		Flat key 6x6x25	1	
75		Locknut M8	3	
76		Switch cable for emergency stop	1	
77		Base assy.,engine	1	